

**5.5-23GHz Driver Amplifier  
GaAs Monolithic Microwave IC**

**PRELIMINARY**

**Description**

The CHA3063 is a two-stage general purpose monolithic medium power amplifier. The backside of the chip is both RF and DC grounds. This helps simplify the assembly process.

The circuit is manufactured with a PM-HEMT process : 0.25µm gate length, via holes through the substrate, air bridges and electron beam gate lithography. It is supplied in chip form.

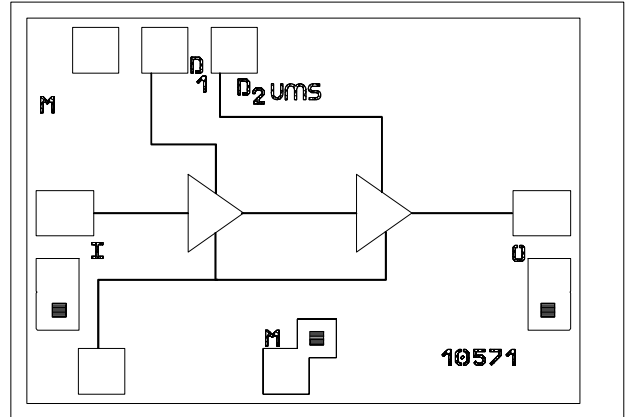

**Main Feature**

- Broad band performance 5.5-23GHz
- 21dBm output power (Psat)
- 19dB gain, ± 1dB gain flatness
- PAE:11%@P-1dB typical
- Chip size : 1.33 x 0.910x 0.1mm

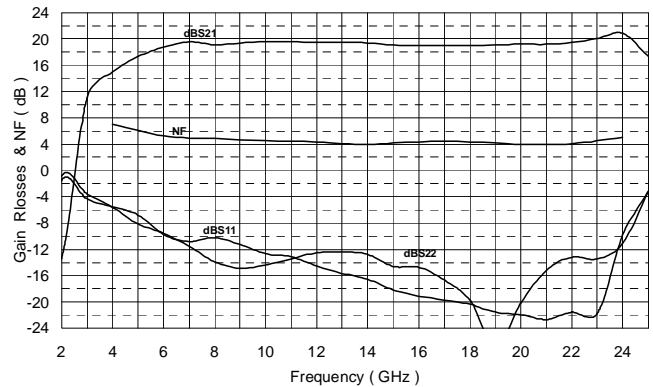

*On wafer typical measurements*

**Main Characteristics**

Tamb = +25°C

Symbol	Parameter	Min	Typ	Max	Unit
Fop	Operating frequency range	5.5		23	GHz
G	Small signal gain	18	19		dB
Pout	Output power, Pin=0dBm	+18	+20		dBm
Id_small_signal	Bias current		160	210	mA

ESD Protection : Electrostatic discharge sensitive device observe handling precautions !

## Electrical Characteristics on wafer

Tamb = +25°C, Vd1 = Vd2 = 4V Vg tuned for Id=160mA (around -0.27V)

Symbol	Parameter	Min	Typ	Max	Unit
Fop	Operating frequency range	5.5		23	GHz
G	Small signal gain	18	19		dB
$\Delta G$	Small signal gain flatness		$\pm 1.0$		dB
Is	Reverse isolation		35		dB
P1dB	CW output power at 1dB compression (1)	+16	+18		dBm
Psat	Saturated Output Power (Pin=0dBm)	+18	+21		dBm
IP3	3 rd order intercept(2)		28		dBm
VSWRin	Input VSWR		2.0:1	2.5:1	
VSWRout	Output VSWR		2.0:1	2.5:1	
NF	Noise figure		4.5	6	dB
Id_small signal	Bias current		160	210	mA

(1) These values are representative for CW on-wafer measurements that are made without bonding wires at the RF ports.

(2) Value representative for CW on jig measurement

## Absolute Maximum Ratings

Tamb. = 25°C (1)

Symbol	Parameter	Values	Unit
Vds	Drain bias voltage_small signal	5.0	V
Ids	Drain bias current_small signal	210	mA
Vg	Gate bias voltage	-2 to +0.4	V
Ig	Gate bias current	0.7	mA
Vgd	Maximum negative gate drain Voltage (Vg-Vd)	-5	V
Pin	Maximum continuous input power Maximum peak input power overdrive (2)	+1 +15	dBm dBm
Ta	Operating temperature range	-40 to +85	°C
Tstg	Storage temperature range	-55 to +125	°C

(1) Operation of this device above any one of these parameters may cause permanent damage.

(2) Duration < 1s.

### Typical Scattering Parameters ( On wafer Sij measurements)

Bias Conditions :  $V_{d1,2} = 4V$ ,  $V_g = -0.27V$ ,  $I_d = 160 \text{ mA}$ .

**PRELIMINARY**

FREQ	S11	S11	S12	S12	S21	S21	S22	S22
GHz	dB	°	dB	°	dB	°	dB	°
1,0	-0,3	-35,6	-60,9	84,0	-12,7	86,9	-0,6	-35,0
2,0	-0,7	-75,6	-63,1	142,8	-13,7	-179,2	-1,4	-67,7
3,0	-3,4	-113,7	-54,5	-53,2	11,6	123,1	-4,7	-93,2
4,0	-5,7	-140,7	-53,1	138,2	15,2	58,5	-6,2	-111,6
5,0	-7,9	-170,3	-43,5	67,4	16,4	19,0	-7,4	-133,3
6,0	-9,0	162,5	-44,2	34,7	18,8	-12,3	-11,1	-149,1
7,0	-11,3	121,8	-41,0	13,6	19,3	-46,9	-12,0	-155,1
8,0	-13,5	82,5	-38,7	-16,7	18,9	-75,2	-11,6	-173,2
9,0	-14,3	39,7	-37,6	-39,6	19,1	-100,4	-12,9	171,7
10,0	-14,0	0,9	-37,1	-61,4	19,3	-125,2	-14,4	165,8
11,0	-13,2	-34,0	-36,7	-82,9	19,5	-150,7	-13,7	164,9
12,0	-13,2	-62,6	-35,6	-107,7	19,6	-175,1	-13,5	148,9
13,0	-15,3	-95,8	-36,0	-126,6	19,5	159,3	-11,9	131,3
14,0	-16,7	-125,2	-35,0	-148,4	19,2	133,1	-11,9	116,0
15,0	-21,2	-125,5	-34,7	-175,9	18,5	111,1	-13,1	95,0
16,0	-18,6	-140,0	-36,4	170,4	18,2	89,1	-14,7	79,9
17,0	-19,8	-124,7	-36,4	137,3	18,1	70,4	-19,5	72,4
18,0	-18,8	-172,0	-38,5	135,9	18,1	44,3	-17,4	72,2
19,0	-20,8	101,6	-37,4	154,6	18,0	22,0	-18,5	57,4
20,0	-19,8	23,1	-35,2	125,8	18,0	-2,5	-19,4	47,4
21,0	-15,4	-14,7	-34,0	101,5	18,2	-26,4	-23,3	32,5
22,0	-14,2	-34,2	-33,8	71,7	18,9	-57,7	-21,4	76,8
23,0	-11,5	-43,5	-35,3	46,5	19,5	-89,3	-16,9	77,6
24,0	-11,6	-30,9	-33,1	-0,4	20,4	-144,0	-6,3	46,6
25,0	-3,9	-46,7	-34,9	-86,0	17,6	153,9	-3,1	-13,3
26,0	-2,0	-74,8	-35,3	-172,0	10,9	104,5	-3,2	-59,0
27,0	-1,3	-99,2	-39,7	157,6	3,9	69,9	-4,3	-90,9
28,0	-1,3	-115,8	-33,9	138,6	-3,5	44,6	-4,7	-113,7
29,0	-1,3	-128,4	-32,3	128,4	-12,1	29,3	-5,0	-133,9
30,0	-1,2	-140,1	-28,7	96,4	-21,0	47,7	-5,9	-153,6

Typical ON JIG MEASUREMENTS (deembedded)

Bias Conditions :  $V_{d1,2} = 4V$ ,  $V_g = -0.27V$ ,  $I_d = 160\text{ mA}$

PRELIMINARY

GAIN & LOSS MEASUREMENTS IN TEST JIG

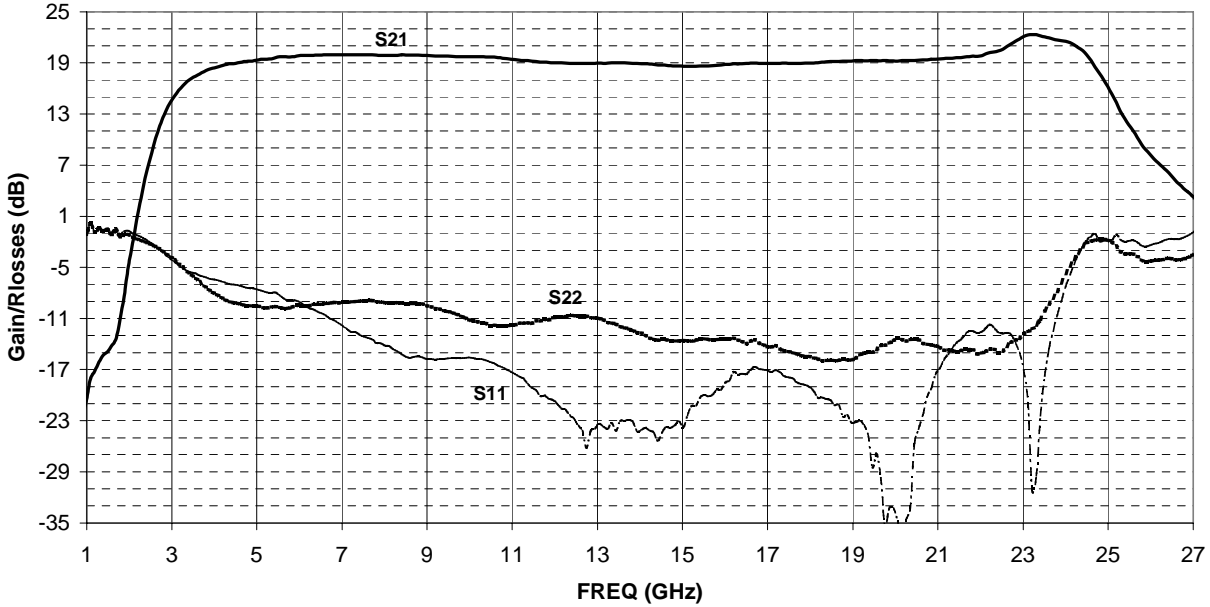

POWER MEASUREMENTS IN TEST JIG (deembedded)

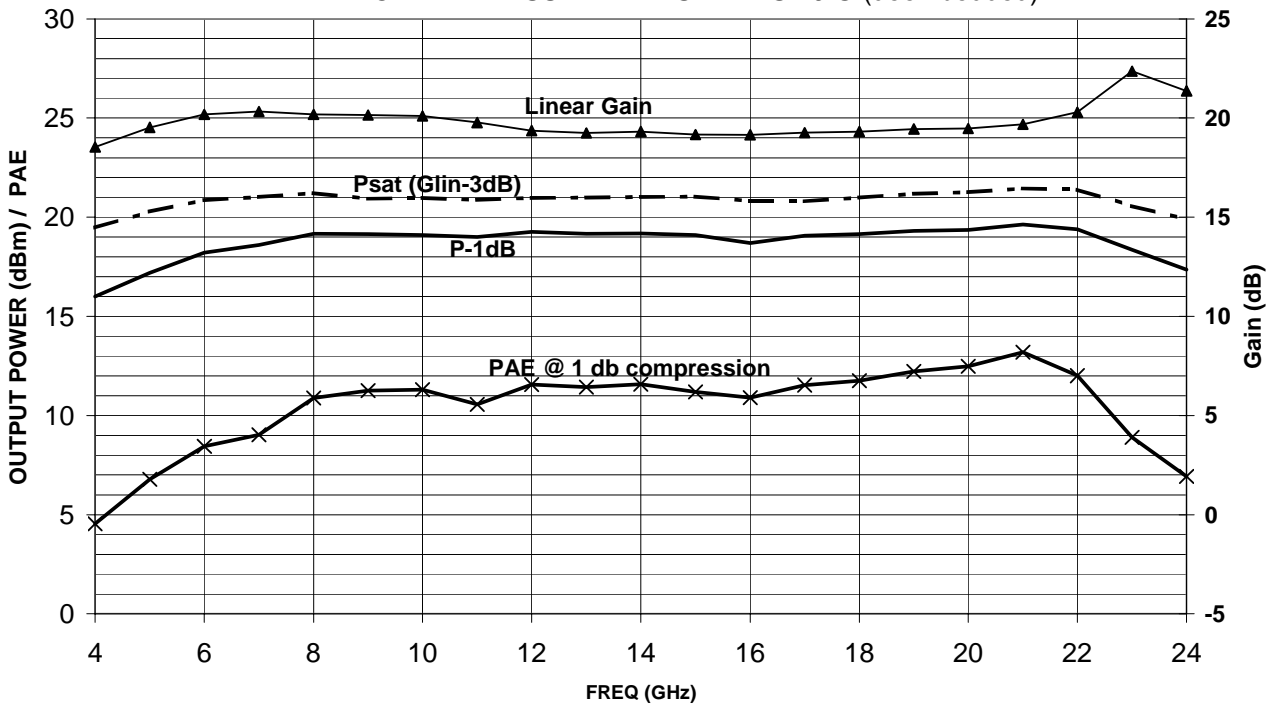

Typical ON JIG POWER MEASUREMENTS (deembedded)

Bias Conditions :  $V_{d1,2} = 4V$ ,  $V_g = -0.27V$ ,  $I_d = 160\text{ mA}$

PRELIMINARY

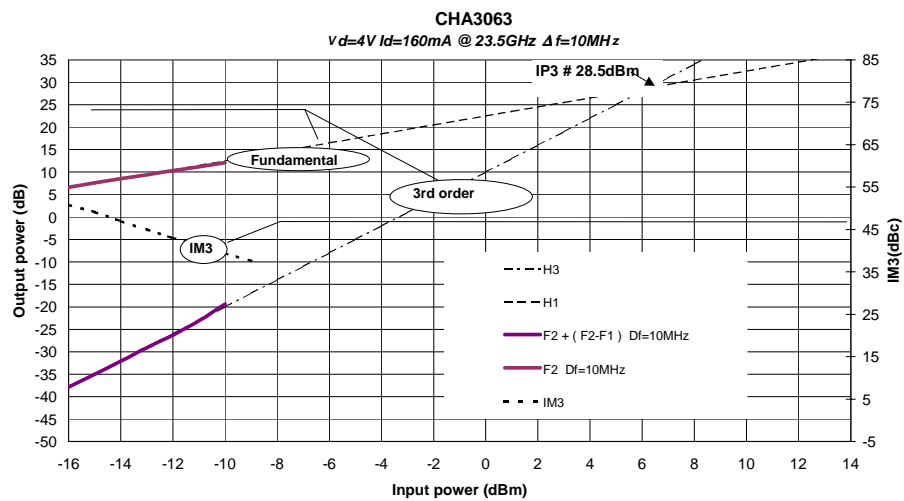
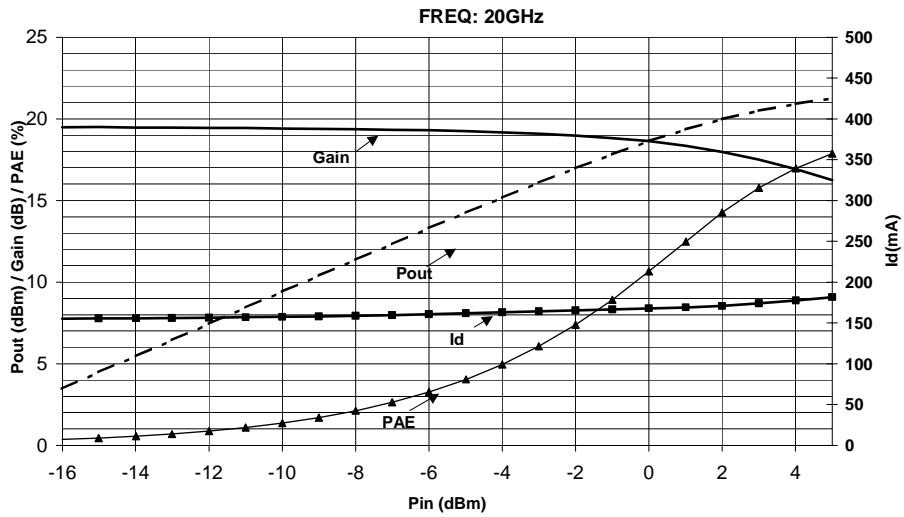
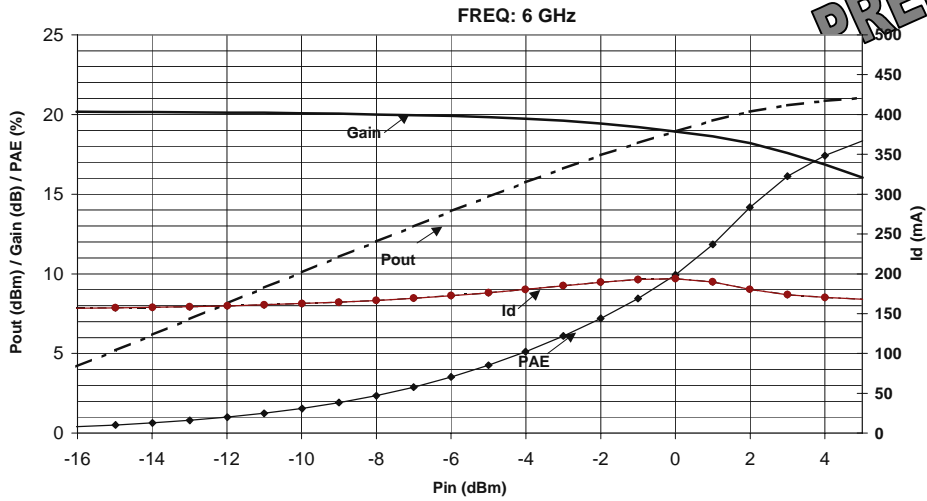

Chip Assembly and Mechanical Data

**PRELIMINARY**

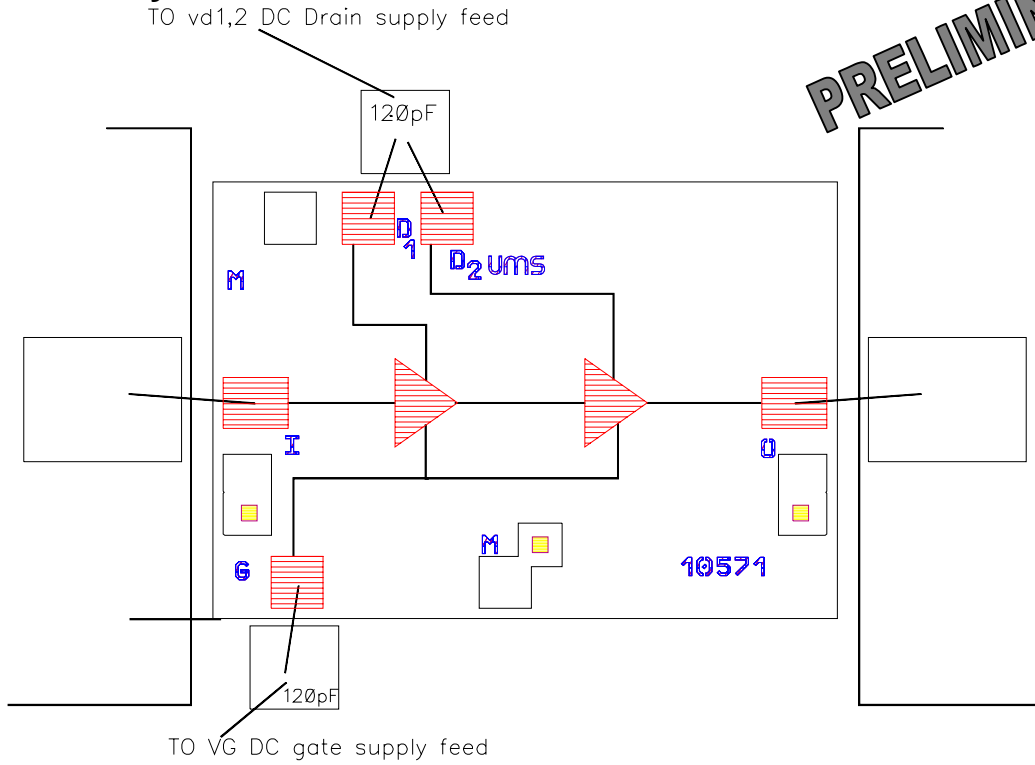

Note :Supply feed should be capacitively bypassed. 25µm diameter gold wire is recommended

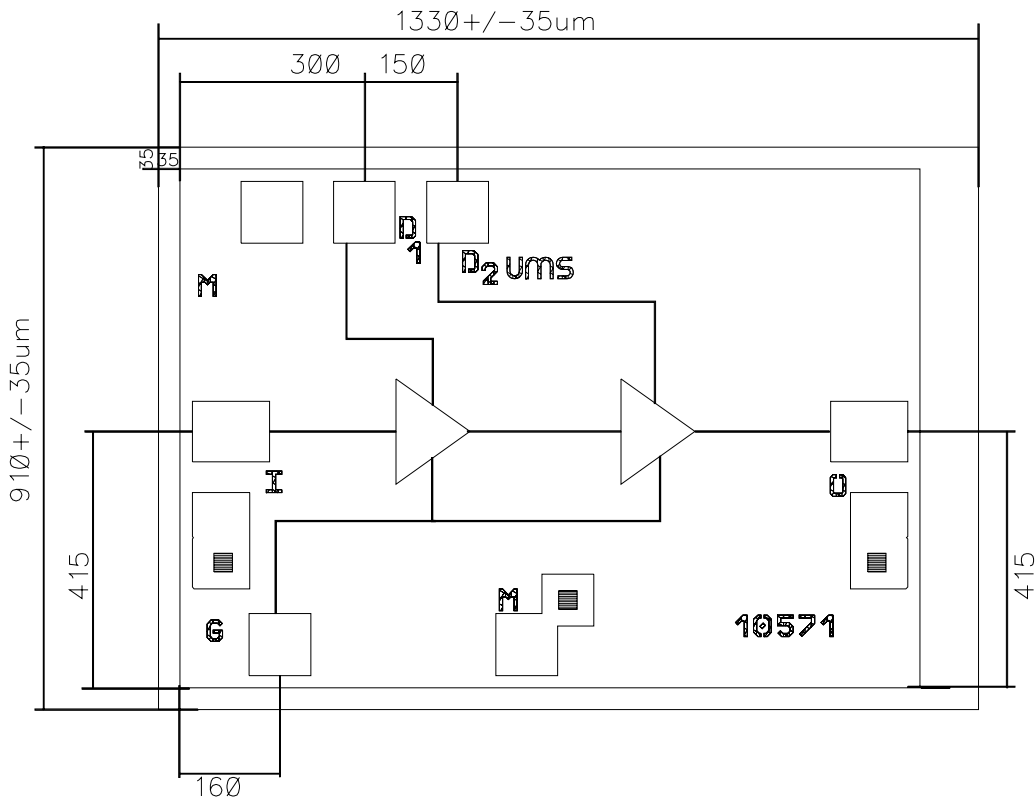

**Bonding pad positions.**  
( Chip thickness : 100µm. All dimensions are in micrometers)

## Ordering Information

Chip form :           CHA3063-99F/00

Information furnished is believed to be accurate and reliable. However **United Monolithic Semiconductors S.A.S.** assumes no responsibility for the consequences of use of such information nor for any infringement of patents or other rights of third parties which may result from its use. No license is granted by implication or otherwise under any patent or patent rights of **United Monolithic Semiconductors S.A.S.** Specifications mentioned in this publication are subject to change without notice. This publication supersedes and replaces all information previously supplied. **United Monolithic Semiconductors S.A.S.** products are not authorised for use as critical components in life support devices or systems without express written approval from **United Monolithic Semiconductors S.A.S.**